

Modello:

# ELIOS

## MADIA ALTA

### 5 ANTE 3 CASSETTI

Elemento:

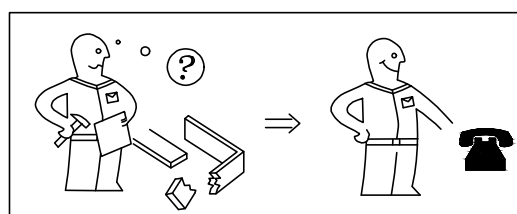
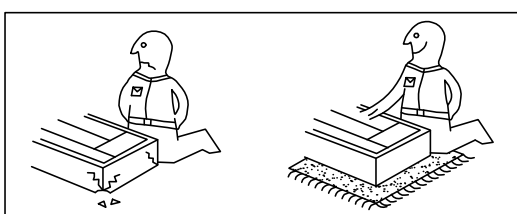
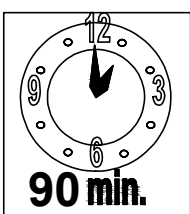
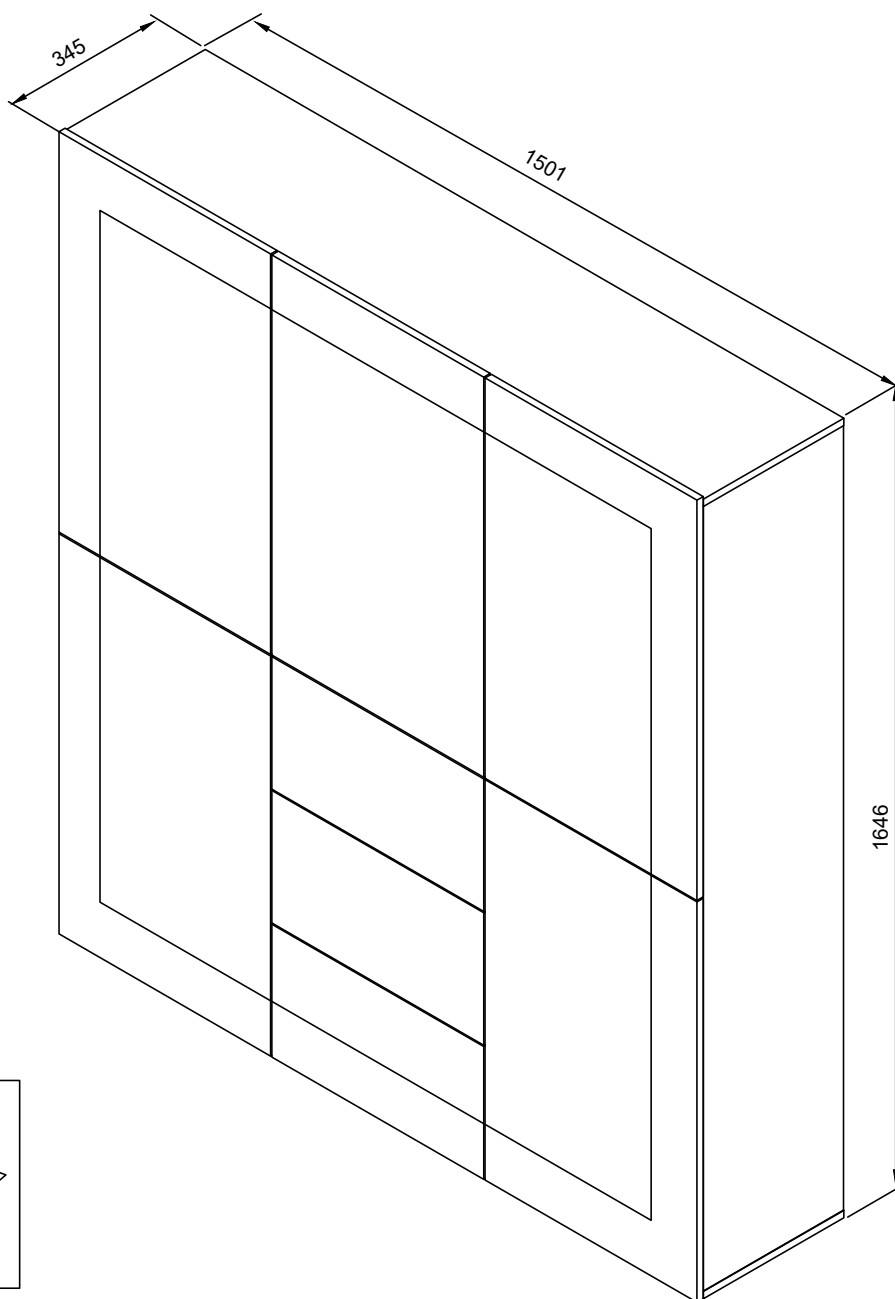

## LEGGERE E CONSERVARE

### AVVERTENZE

Montaggio e installazione: Il prodotto deve essere montato e installato esclusivamente da persone adulte. Prima di procedere, leggere attentamente le istruzioni qui fornite. Sicurezza e responsabilità: La mancata osservanza delle istruzioni può comportare gravi rischi per la sicurezza personale, oltre a possibili danni al prodotto e all'ambiente circostante. Il produttore non si assume alcuna responsabilità per eventuali danni a persone o cose derivanti da un montaggio, fissaggio o ancoraggio non corretti. Controllo preliminare: Prima di iniziare il montaggio, verificare di avere tutti gli elementi di ferramenta e assicurarsi che nessuna componente sia danneggiata. In caso di difetti o discrepanze, contattare il servizio clienti. Reso e gestione danni da trasporto: In caso di reso o danni causati dal trasporto, è importante conservare l'imballaggio originale e contattare tempestivamente l'assistenza clienti per la risoluzione del problema.

### ATTENZIONE

Conservare tutte le parti di ferramenta e gli imballaggi lontano dai bambini e non permettere loro di giocare con il prodotto. Preparazione dell'area di montaggio: scegliere una zona di lavoro pulita, ampia e su una superficie piana. Evitare superfici dure che possano danneggiare il prodotto; è preferibile utilizzare un tappeto o un materiale protettivo. Sicurezza durante il montaggio: utilizzare occhiali di protezione e guanti da lavoro per prevenire possibili infortuni. Prestare attenzione, poiché i componenti lubrificati, come le guide, possono macchiare.

### CURA E MANUTENZIONE

Protezione dal calore e dalla luce: mantenere il prodotto lontano da fonti di calore diretto (non appoggiare pentole e/o prodotti molto caldi potrebbero compromettere il materiale) e dalla luce solare prolungata, poiché ciò potrebbe causare sbiadimento del colore. Pulizia e cura della superficie: per preservare il prodotto, effettuare regolarmente la pulizia con un panno morbido per evitare graffi e utilizzare solo detersivi non aggressivi. Non è necessario applicare cere. Evitare prodotti abrasivi: non utilizzare solventi abrasivi o detersivi chimici aggressivi, poiché possono danneggiare la finitura del prodotto. Rimuovere subito qualsiasi deposito d'acqua o traccia di liquido tamponando con un panno morbido e pulito, per evitare danni alla superficie. Controllo periodico: verificare periodicamente che tutti i componenti strutturali e di fissaggio del prodotto siano in buone condizioni, ben serrati e pienamente funzionali.

### PRECAUZIONI

Non tossico: il prodotto, se utilizzato per la destinazione d'uso prevista, non presenta rischi tossici o dannosi per le persone e l'ambiente.

Modifiche non autorizzate: itamoby non è responsabile per danni a persone, animali o cose causati da modifiche non autorizzate o interventi arbitrari di terzi sui suoi prodotti. Uso interno: salvo diversa indicazione, il prodotto è destinato esclusivamente a un uso interno. Evitare utilizzi impropri o scorretti rispetto alla funzione per cui è stato progettato e realizzato.

### GARANZIA

In base al Codice del Consumo italiano (D.Lgs. n. 206/2005), questo prodotto è coperto da una garanzia legale per difetti di conformità, valida per 24 mesi dalla data di consegna ai privati. La garanzia prevede la riparazione o sostituzione dell'articolo, o di sue parti, a condizione che venga utilizzato conformemente alle istruzioni e alla destinazione d'uso prevista.

La garanzia non copre:

- installazione effettuata con ferramenta o componenti mancanti
  - installazione effettuata con ferramenta o componenti danneggiati
  - danni dovuti a normale usura, come scolorimento per esposizione alla luce, infiltrazioni d'acqua, eccessivo calore o uso improprio, così come la mancata osservanza delle corrette pratiche di manutenzione descritte.
- Decadenza della garanzia: La garanzia è considerata nulla qualora il prodotto venga modificato arbitrariamente dal cliente. Si ricorda inoltre che effettuare il montaggio nelle condizioni sopra indicate può compromettere la sicurezza del prodotto, con il rischio di danni materiali o lesioni.

### PRIVACY

In conformità al Regolamento UE 2016/679, relativo alla protezione delle persone fisiche con riguardo al trattamento dei dati personali, si informa che i dati saranno trattati esclusivamente per le finalità legate alla corretta gestione del rapporto commerciale. Per maggiori dettagli, è possibile consultare l'informativa completa al link: <https://www.iubenda.com/privacy-policy/32120238/legal>. Ai sensi dell'art. 6, par. 1, lett. b) e c) del Regolamento UE 2016/679, non è necessario acquisire il consenso esplicito per il trattamento dei dati personali da parte del Titolare del trattamento.

## READ AND KEEP

### WARNINGS

Assembly and installation: The product must be assembled exclusively by adults. Carefully read the provided instruction manual before proceeding. Safety and responsibility: failure to follow the instructions may cause serious risks to personal safety and potential damage to the product and the surrounding environment. The manufacturer does not take responsibility for potential damages to people or objects caused by improper assembly, fixing or anchoring. Preliminary check: Before starting the assembly, ensure that all hardware elements are present and each component is not damaged. In case of discrepancies or defects, reach out to customer service. Returns and transportation damage management: In case of returns or damage caused during transportation, it is important to keep the original packaging and promptly contact customer service for issue resolution.

### ATTENTION

Keep each hardware part and packaging out of reach of children and do not allow them to play with the product. Assembly area setup: choose a clean, wide and flat surface. Avoid hard surfaces that might damage the product. Using a carpet or protective material is preferable. Safety during assembly: wear protective glasses and gloves in order to avoid potential injuries. Be mindful that lubricated elements such as table sliders may stain. CARE AND MAINTAINANCE Protection from heat and light: Keep the product away from direct heat sources (laying hot pans or objects may compromise the materials) and avoid prolonged exposure to light as this may cause colour fading. Cleaning and surface care: To preserve the product, regularly clean the surface, using a soft cloth to avoid scratches and use mild detergent. Applying waxes is not necessary. Avoid abrasive products: Avoid abrasive solvents and harsh detergents, as they may damage the product. Immediately remove any water deposit or liquid traces by dabbing with a clean and soft cloth to prevent surface damage. Regular inspection: Periodically check that all structural and fastening components are in good condition, properly tightened, and fully functional.

### PRECAUTIONS

Non toxic: the product does not pose a toxic hazard or danger for the environment or people when used for its intended purpose. Unauthorized modifications: Itamoby is not responsible for any damage to persons, animals or objects caused by unauthorized alterations or interventions by third parties on its products. Internal use: unless stated otherwise, the product is exclusively intended for indoor use. Avoid improper or incorrect use contrary to the function for which the product has been designed and manufactured.

### WARRANTY

According to the Italian Consumer Code (D.Lgs. n. 206/2005), this product is covered by legal warranty for conformity defects, valid for 24 months from the delivery date to the customer. Warranty includes repair or replacement of the product or its parts, provided the product is used in accordance with the instructions and the intended purpose. Warranty does not cover:

- assembly done with missing hardware or components
- assembly done with damaged hardware
- damages caused by normal use, such as fading due to light exposure, water infiltration, excessive heat or improper use as well as failure to adhere to the correct maintenance practices described.

Warranty expiration: Warranty is void if the product is arbitrarily modified by the customer. Be aware that assembling the product in such a manner may compromise its safety, risking material damage or injury.

### PRIVACY

In accordance with EU Regulation 2016/679, regarding the protection of individuals with respect to the processing of personal data, please be informed that the data will be processed exclusively for purposes related to the proper management of the business relationship. For further details, the privacy notice can be consulted in its entirety at: <https://www.iubenda.com/privacy-policy/32120238/legal>. Under Article 6, paragraph 1, letters b) and c) of EU Regulation 2016/679, explicit consent is not required for the processing of personal data by the Data Controller.

## À LIRE ET À CONSERVER

### AVERTISSEMENT

Montage et installation : Le produit doit être monté et installé uniquement par des adultes. Veuillez lire attentivement les instructions fournies avant de procéder. Sécurité et responsabilité : Le non-respect de ces instructions peut entraîner de graves risques pour la sécurité personnelle, ainsi que des dommages potentiels au produit et à l'environnement. Le fabricant décline toute responsabilité pour tout dommage corporel ou matériel résultant d'un montage, d'une fixation ou d'un ancrage incorrect. Contrôle préliminaire : Avant de commencer l'assemblage, veuillez vérifier que vous disposez de tous les éléments de quincaillerie et vous assurer qu'aucune pièce n'est endommagée. En cas de défauts ou de pièces manquantes, veuillez contacter notre service client. Retour et gestion des dommages de transport : En cas de retour ou de dommages causés pendant le transport, il est important de conserver l'emballage d'origine et de contacter rapidement notre service client pour résoudre le problème.

### AVIS IMPORTANT

Il est important de garder tous les éléments de fixation et les emballages à l'abri des enfants. Ne laissez pas les enfants jouer avec le produit. Préparez un espace de travail sûr : choisissez une zone propre, spacieuse et plane pour assembler votre produit. Évitez les surfaces dures qui pourraient endommager le produit. Il est préférable d'utiliser un tapis ou un matériau de protection. Sécurité lors du montage : Pour votre sécurité, nous vous recommandons de porter des lunettes de protection et des gants de travail lors du montage de ce produit. Attention : certaines pièces lubrifiées, telles que les rails, peuvent tacher. Veuillez manipuler ces éléments avec précaution.

### ENTRETIEN ET MAINTENANCE

À protéger de la chaleur et de la lumière directes. Éviter tout contact avec des surfaces chaudes. Une exposition prolongée au soleil peut causer une décoloration. Nettoyage et entretien de la surface: Afin de préserver votre produit, nettoyez-le régulièrement à l'aide d'un chiffon doux pour éviter les rayures et n'utilisez que des détergents non abrasifs. L'application de cires n'est pas nécessaire. Éviter les produits abrasifs : n'utilisez pas de solvants abrasifs ou de produits nettoyants chimiques agressifs, car ils risquent d'endommager la finition du produit. Enlevez immédiatement toute trace d'eau ou tout liquide en tamponnant délicatement avec un chiffon doux et propre, afin d'éviter d'abîmer la surface.

Inspection régulière : Il est recommandé d'effectuer des inspections régulières afin de s'assurer que tous les éléments structurels et de fixation du produit sont en parfait état, correctement serrés et qu'ils remplissent pleinement leur fonction.

### PRÉCAUTIONS

Non toxique: Le produit, utilisé conformément à son usage prévu, ne présente aucun risque toxique ou nocif pour les personnes ou l'environnement. Modifications non autorisées : Itamoby décline toute responsabilité pour les dommages corporels, matériels ou causés aux animaux résultant de modifications non autorisées ou d'interventions arbitraires de tiers sur ses produits. Usage interne : sauf indication contraire, ce produit est destiné exclusivement à un usage intérieur. Évitez toute utilisation inappropriée ou ne correspondant pas à sa fonction d'origine.

### GARANTIE

Conformément au Code de la consommation italien (D.Lgs. n° 206/2005), ce produit bénéficie d'une garantie légale contre les défauts de conformité, valable 24 mois à compter de la date de livraison aux particuliers. La garantie couvre la réparation ou le remplacement de l'article, ou de ses pièces, à condition qu'il soit utilisé conformément aux instructions et à l'usage auquel il est destiné.

La garantie ne couvre pas :

- l'installation réalisée avec de la quincaillerie ou des composants manquants.
- l'installation réalisée avec de la quincaillerie ou des composants endommagés.
- Les dommages dus à l'usure normale, tels que la décoloration due à l'exposition directe à la lumière, les infiltrations d'eau, la chaleur excessive ou une utilisation inappropriée, ainsi que le non-respect des bonnes pratiques d'entretien décrites.

Perte de garantie : La garantie sera annulée en cas de modification non autorisée du produit par le client. Nous rappelons également que le montage du produit dans des conditions autres que celles spécifiées ci-dessus peut compromettre la sécurité de l'appareil et entraîner des dommages matériels ou des blessures.

### POLITIQUE DE CONFIDENTIALITÉ

Conformément au Règlement (UE) 2016/679 relatif à la protection des personnes physiques à l'égard du traitement des données à caractère personnel, nous vous informons que vos données seront traitées uniquement dans le but de gérer notre relation commerciale. Pour plus d'informations détaillées, veuillez consulter notre politique de confidentialité complète à l'adresse suivante : <https://www.iubenda.com/privacy-policy/32120238/legal>. Conformément à l'article 6, paragraphe 1, points b) et c) du Règlement UE 2016/679, votre consentement explicite n'est pas requis pour le traitement de vos données personnelles par le responsable du traitement.

## LEER Y GUARDAR

### ADVERTENCIAS

Montaje e instalación: Este producto debe ser montado e instalado únicamente por adultos. Antes de comenzar, lea atentamente las instrucciones proporcionadas aquí.

Seguridad y responsabilidad: El incumplimiento de estas instrucciones puede acarrear graves riesgos para la seguridad personal, así como posibles daños al producto y al entorno. El fabricante no se hace responsable por ningún daño a personas o cosas derivado de un montaje, fijación o anclaje incorrecto.

Comprobación previa: Antes de comenzar el montaje, verifique que tenga todas las piezas de ferretería y asegúrese de que ninguna componente esté dañada. En caso de defectos o discrepancias, contacte con el servicio de atención al cliente.

Devolución y gestión de daños por transporte: En caso de devolución o daños causados por el transporte, es importante conservar el embalaje original y ponerse en contacto con el servicio de atención al cliente lo antes posible para resolver el problema.

### ATENCIÓN

Conservar todas las piezas de ferretería y los embalajes fuera del alcance de los niños y no permitir que jueguen con el producto.

Preparación del área de montaje: elegir un área de trabajo limpia, amplia y sobre una superficie plana. Evitar superficies duras que puedan dañar el producto; es preferible utilizar una alfombra o un material protector.

Seguridad durante el montaje: utilizar gafas de protección y guantes de trabajo para prevenir posibles accidentes. Prestar atención, ya que los componentes lubricados, como las guías, pueden manchar.

### CUIDADO Y MANTENIMIENTO

Protección del calor y la luz: mantener el producto alejado de fuentes de calor directo (no colocar ollas y/o productos muy calientes, ya que podrían dañar el material) y de la luz solar prolongada, ya que esto podría causar decoloración.

Limpieza y cuidado: para preservar el producto, limpiar regularmente con un paño suave para evitar rayones y utilizar sólo detergentes no agresivos. No es necesario aplicar ceras. Evitar productos abrasivos: no utilizar solventes abrasivos o detergentes químicos agresivos, ya que pueden dañar el acabado del producto. Eliminar inmediatamente cualquier depósito de agua o rastro de líquido secando con un paño suave y limpio, para evitar daños en la superficie.

Control periódico: verificar periódicamente que todos los componentes estructurales y de fijación del producto estén en buenas condiciones, bien apretados y completamente funcionales.

### PRECAUCIONES

No tóxico: el producto, si se utiliza para el uso previsto, no presenta riesgos tóxicos o dañinos para las personas y el medio ambiente.

Modificaciones no autorizadas: itamoby no se responsabiliza por daños a personas, animales o cosas causados por modificaciones no autorizadas o intervenciones arbitrarias de terceros en sus productos.

Uso interior: salvo indicación contraria, el producto está destinado exclusivamente a un uso interior. Evitar usos indebidos o incorrectos respecto a la función para la que fue diseñado y fabricado.

### GARANTÍA

De conformidad con Codice del Consumo italiano (D.Lgs. n. 206/2005), este producto está cubierto por una garantía legal de conformidad por defectos por un período de 24 meses a partir de la fecha de entrega al consumidor. La garantía cubre la reparación o sustitución del producto, o de sus partes, a condiciones que se haya utilizado de acuerdo con las instrucciones y para el uso previsto.

La garantía no cubre:

- Instalación realizada con ferretería o componentes faltante
- Instalación realizada con ferretería o componentes dañados
- Daños causados por el desgaste natural, como decoloración por exposición a la luz, filtraciones de agua, exceso de calor o uso inadecuado, así como el incumplimiento de las correctas prácticas de mantenimiento descritas.

Pérdida de la garantía: La garantía perderá su validez en caso de que el producto sea modificado arbitrariamente por el cliente. Se recuerda además que realizar el montaje en las condiciones indicadas en el párrafo anterior puede comprometer la seguridad del producto, con el riesgo de daños materiales o lesiones.

### PRIVACIDAD

De conformidad con el Reglamento UE 2016/679, relativo a la protección de las personas físicas en lo que respecta al tratamiento de datos personales, se informa que los datos serán tratados exclusivamente para las finalidades relacionadas con la correcta gestión de la relación comercial. Para obtener más detalles, puede consultar la información completa en el siguiente enlace: <https://www.iubenda.com/privacy-policy/32120238/legal>. De acuerdo con el artículo 6, apartado 1, letras b) y c) del Reglamento UE 2016/679, no es necesario obtener el consentimiento explícito para el tratamiento de datos personales por parte del Responsable del tratamiento.

## LESEN UND AUFBEWAHREN

### WARNUNGEN

Montage und Installation: Das Produkt darf nur von Erwachsenen montiert und installiert werden. Bitte lesen Sie die hier aufgeführten Anweisungen sorgfältig durch, bevor Sie mit der Montage beginnen.

Sicherheit und Haftung: Die Nichtbeachtung der Anweisungen kann zu ernsthaften Risiken für die persönliche Sicherheit sowie zu möglichen Schäden am Produkt und seiner Umgebung führen. Der Hersteller übernimmt keine Haftung für Personen- oder Sachschäden, die durch unsachgemäße Montage, Befestigung oder Installation entstehen.

Vorabkontrolle: Überprüfen Sie vor Beginn der Montage, ob alle Beschläge vorhanden sind und ob keine Bauteile beschädigt sind. Bei Produktschäden oder Unstimmigkeiten wenden Sie sich bitte an den Kundendienst.

Rücksendung und Behandlung von Transportschäden: Im Falle einer Rücksendung oder eines Transportschadens ist es wichtig, die Originalverpackung aufzubewahren und den Kundendienst umgehend zu kontaktieren, um das Problem zu lösen.

### VORSICHT

Halten Sie alle Teile und die Verpackung von Kindern fern und lassen Sie sie nicht mit dem Produkt spielen.

Vorbereitung des Montagebereichs: Wählen Sie einen sauberen, großen Arbeitsbereich auf einer ebenen Fläche. Vermeiden Sie harte Oberflächen, die das Produkt beschädigen könnten; verwenden Sie vorzugsweise einen Teppich oder ein Schutzmaterial.

Sicherheit bei der Montage: Tragen Sie eine Schutzbrille und Arbeitshandschuhe, um mögliche Verletzungen zu vermeiden. Seien Sie vorsichtig, da geschmierte Komponenten, wie z. B. Führungen, Flecken verursachen können.

### PFLEGE UND WARTUNG

Schutz vor Hitze und Licht: Halten Sie das Produkt von direkten Wärmequellen (stellen Sie keine Töpfe und/oder sehr heiße Produkte darauf, da dies das Material angreifen kann) und längerer Sonneneinstrahlung fern, da dies zum Verblasen der Farben führen kann.

Reinigung und Pflege der Oberfläche: Um das Produkt zu schützen, reinigen Sie es regelmäßig mit einem weichen Tuch, um Kratzer zu vermeiden, und verwenden Sie nur nicht-aggressive Reinigungsmittel. Es ist nicht notwendig, Wachs aufzutragen.

Vermeiden Sie Scheuermittel: Verwenden Sie keine Scheuermittel oder aggressive chemische Reinigungsmittel, da diese die Oberfläche des Produkts beschädigen können. Tupfen Sie Wasser oder Flüssigkeitssuren sofort mit einem weichen, sauberen Tuch ab, um Schäden an der Oberfläche zu vermeiden.

Regelmäßige Inspektion: Überprüfen Sie regelmäßig, ob alle Struktur- und Befestigungsteile des Produkts in gutem Zustand, gut angezogen und voll funktionsfähig sind.

### VORSICHTSMASSNAHMEN

Ungiftig: Das Produkt stellt bei bestimmungsgemäßer Verwendung keine toxischen oder schädlichen Risiken für Mensch und Umwelt dar.

Unerlaubte Änderungen: itamoby ist nicht verantwortlich für Schäden an Personen, Tieren oder Eigentum, die durch unerlaubte Änderungen oder willkürliche Eingriffe Dritter an seinen Produkten verursacht werden. Interner Gebrauch: Sofern nicht anders angegeben, ist das Produkt nur für den internen Gebrauch bestimmt. Vermeiden Sie eine unsachgemäße oder falsche Verwendung im Hinblick auf die Funktion, für die es konzipiert und hergestellt wurde.

### GARANTIE

Gemäß dem italienischen Verbraucherschutzgesetz (Gesetzesdekret Nr. 206/2005) gilt für dieses Produkt eine gesetzliche Garantie für Konformitätsmängel, die für 24 Monate ab dem Datum der Lieferung an Privatpersonen gültig ist. Die Garantie sieht die Reparatur oder den Ersatz des Artikels oder von Teilen davon vor, vorausgesetzt, er wird entsprechend der Gebrauchsanweisung und dem Verwendungszweck verwendet.

Die Garantie erstreckt sich nicht auf:

- Installation, die mit fehlenden Teilen oder Komponenten durchgeführt wird
  - Installation mit beschädigten Bauteilen oder Komponenten-Schäden, die auf normalen Verschleiß zurückzuführen sind, wie z. B. Verfärbungen durch Lichteinwirkung, Wassereintritt, übermäßige Hitze oder unsachgemäßen Gebrauch sowie die Nichterhaltung der beschriebenen Wartungspraktiken.
- Verfall der Garantie: Die Garantie gilt als nichtig, wenn das Produkt vom Kunden eigenmächtig verändert wird. Bitte beachten Sie auch, dass die Installation unter den oben genannten Bedingungen die Sicherheit des Produkts beeinträchtigen kann und die Gefahr von Sachschäden oder Verletzungen besteht.

### PRIVACY

Gemäß der Verordnung (EU) 2016/679 zum Schutz natürlicher Personen bei der Verarbeitung personenbezogener Daten informieren wir Sie darüber, dass Ihre Daten ausschließlich zu Zwecken im Zusammenhang mit der ordnungsgemäßen Verwaltung der Geschäftsbeziehung verarbeitet werden. Weitere Einzelheiten können Sie dem vollständigen Informationsschreiben unter folgendem Link entnehmen: <https://www.iubenda.com/privacy-policy/32120238/legal>. Gemäß Artikel 6 Absatz 1 Buchstaben b und c der Verordnung (EU) 2016/679 ist es nicht erforderlich, eine ausdrückliche Einwilligung für die Verarbeitung personenbezogener Daten durch den für die Verarbeitung Verantwortlichen einzuholen.

## LEIA E GARDE

### AVISOS

Montagem e instalação: Este produto deve ser montado e instalado apenas por adultos. Antes de começar, leia atentamente as instruções fornecidas aqui.

Segurança e responsabilidade: O não cumprimento destas instruções pode acarretar graves riscos para a segurança pessoal, assim como possíveis danos ao produto e ao meio ambiente. O fabricante não se responsabiliza por quaisquer danos a pessoas ou coisas decorrentes de uma montagem, fixação ou ancoragem incorreta.

Verificação prévia: Antes de iniciar a montagem, verifique se você tem todas as peças de ferragaria e certifique-se de que nenhum componente esteja danificado. Em caso de defeitos ou discrepâncias, entre em contato com o serviço de atendimento ao cliente.

Devolução e gestão de danos por transporte: Em caso de devolução ou danos causados pelo transporte, é importante conservar a embalagem original e entrar em contato com o serviço de atendimento ao cliente o mais rápido possível para resolver o problema.

### ATENÇÃO

Conservar todas as peças de ferragaria e as embalagens fora do alcance das crianças e não permitir que brinquem com o produto.

Preparação da área de montagem: escolha uma área de trabalho limpa, ampla e sobre uma superfície plana. Evite superfícies duras que possam danificar o produto; é preferível utilizar um tapete ou um material protetor.

Segurança durante a montagem: utilize óculos de proteção e luvas de trabalho para prevenir possíveis acidentes. Preste atenção, pois os componentes lubrificados, como as guías, podem manchar.

### CUIDADO E MANUTENÇÃO

Proteção contra o calor e luz: manter o produto longe de fontes de calor direto (não colocar painéis e/ou produtos muito quentes, pois podem danificar o material) e da luz solar prolongada, pois isso pode causar descoloração.

Limpeza e cuidado: para preservar o produto, limpar regularmente com um pano macio para evitar riscos e utilizar apenas detergentes não agressivos. Não é necessário aplicar ceras.

Evitar produtos abrasivos: não utilizar solventes abrasivos ou detergentes químicos agressivos, pois podem danificar o acabamento do produto. Remover imediatamente qualquer depósito de água ou vestígios de líquido secando com um pano macio e limpo, para evitar danos na superfície.

Verificação periódica: verificar periodicamente se todos os componentes estruturais e de fixação do produto estão em boas condições, bem apertados e completamente funcionais.

### PRECAUÇÕES

Non tóxico: o produto, se utilizado conforme as instruções, não apresenta riscos tóxicos ou prejudiciais para pessoas e o meio ambiente.

Modificações não autorizadas: a Itamoby não se responsabiliza por danos a pessoas, animais ou coisas causados por modificações não autorizadas ou alterações realizadas por terceiros em seus produtos.

Uso interno: a menos que indicado o contrário, o produto é destinado exclusivamente para uso interno. Evitar usos inadequados ou que não correspondam à função para a qual foi projetado e fabricado.

### GARANTIA

De acordo com o Código do Consumidor italiano (D.Lgs. n. 206/2005), este produto está coberto por uma garantia legal de conformidade por defeitos por um período de 24 meses a contar da data de entrega ao consumidor. A garantia cobre a reparação ou substituição do produto, ou das suas partes, desde que tenha sido utilizado de acordo com as instruções e para a finalidade a que se destina.

A garantia não cobre:

- Instalação realizada com ferragaria ou componentes em falta
- Instalação realizada com ferragaria ou componentes danificados
- Danos causados por desgaste natural, como descoloração por exposição à luz, infiltrações de água, excesso de calor ou utilização indevida, assim como o incumprimento das corretas práticas de manutenção descritas.

Perda da garantia: A garantia perderá a sua validade caso o produto seja modificado arbitrariamente pelo cliente. Recorde-se ainda que realizar a montagem nas condições indicadas no parágrafo anterior pode comprometer a segurança do produto, com o risco de danos materiais ou lesões.

### PRIVACIDADE

De acordo com o Regulamento UE 2016/679, relativo à proteção das pessoas singulares no que diz respeito ao tratamento de dados pessoais, informa-se que os dados serão tratados exclusivamente para as finalidades relacionadas com a correta gestão da relação comercial. Para obter mais detalhes, pode consultar a informação completa no seguinte link: <https://www.iubenda.com/privacy-policy/32120238/legal>. De acordo com o artigo 6.º, n.º 1, alíneas b) e c) do Regulamento UE 2016/679, não é necessário obter o consentimento explícito para o tratamento de dados pessoais por parte do responsável pelo tratamento.



06 07 08  
09 10

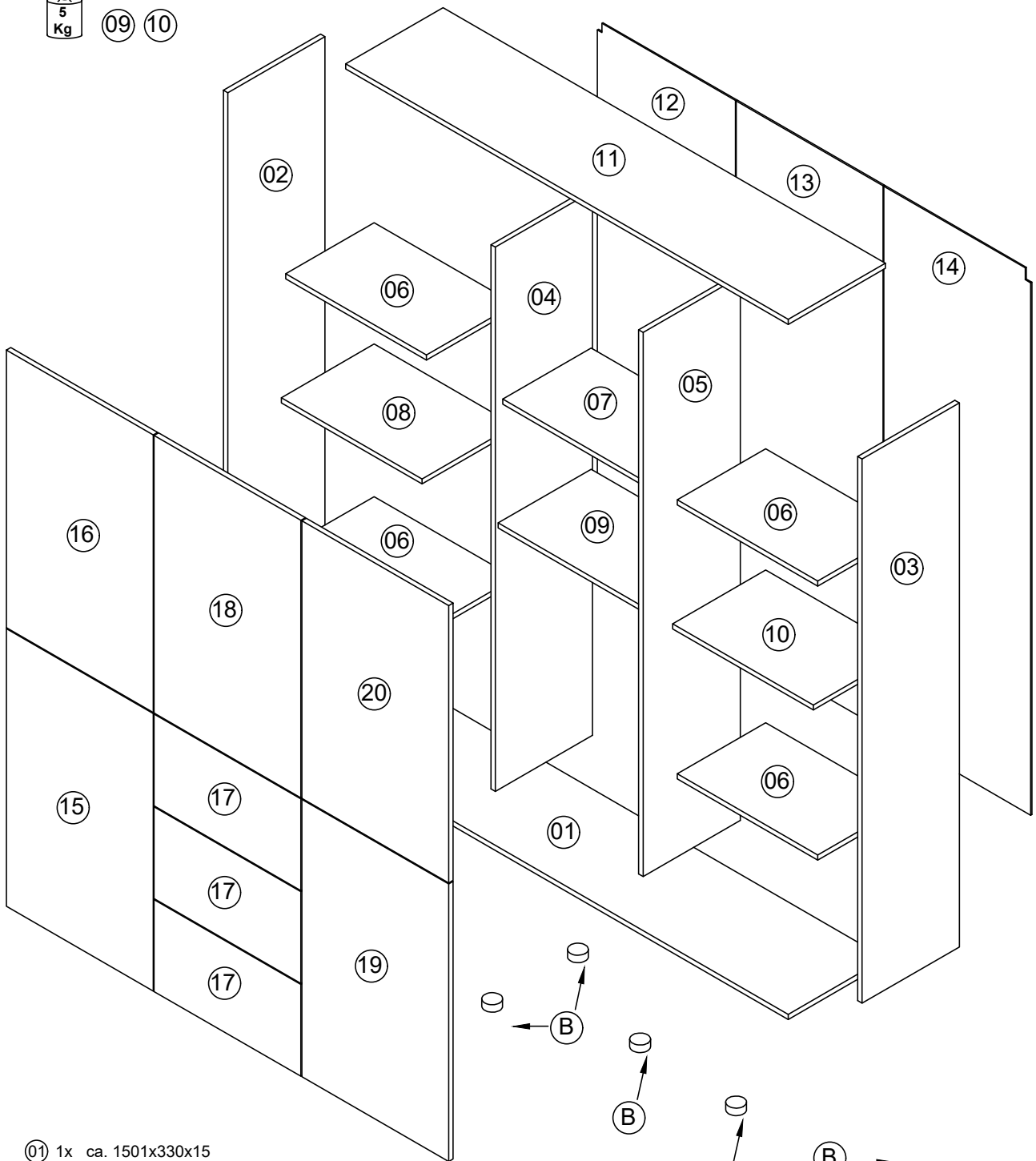

- |                          |                      |
|--------------------------|----------------------|
| 01 1x ca. 1501x330x15    | 12 1x ca. 1610x487   |
| 02 1x c.a. 1598x329.5x15 | 13 1x ca. 1610x494   |
| 03 1x ca. 1598x329.5x15  | 14 1x ca. 1610x487   |
| 04 1x ca. 1598x329.5x15  | 15 1x ca. 815x498x15 |
| 05 1x ca. 1598x329.5x15  | 16 1x ca. 815x498x15 |
| 06 4x ca. 477x300x15     | 17 3x ca. 270x498x15 |
| 07 1x ca. 486x300x15     | 18 1x ca. 815x498x15 |
| 08 1x ca. 477x300x15     | 19 1x ca. 815x498x15 |
| 09 1x ca. 486x300x15     | 20 1x ca. 815x498x15 |
| 10 1x ca. 477x300x15     | B 6x ca. D.50xH.20   |
| 11 1x ca. 1501x330x15    |                      |

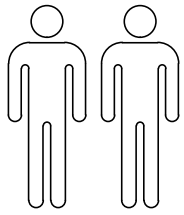

DUE PERSONE

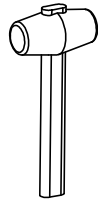

MARTELLO

CACCIAVITE  
A CROCE







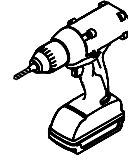

















CUTTER

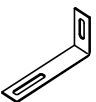

METRO



TRAPANO

Descrizione	n.	Descrizione	n.
 (C) ECCENTRICO ART. EX1515/EC16 D.15 SP. 12 ZINCATO	20	 (R1) CERNIERA D. 35 COLLO 8 SLA4808 AMMORTIZZATE SLIDE-ON	2
 (E) PERNO ART. TS0307/TM02 F.L. 7x35x6 INT. 24 ZINCATO	20	 (S) BASETTA H. 0 TSL500 C/CODULI DA 5 X CERN. AMMORT.	10
 (R) TAPPI COPRIECC. D.17 x EC16 BIANCHI CF14	20	 (T) VITI AUTOF. TP 3.5x15 ZINCATE (AMBROVIT)	32
 (R) TAPPI COPRIECC. D.17 x EC16 GRIGIO COL.31	8	 (B) PIEDE D.50 H.20 POLIPROPILENE NERO	6
 (R) TAPPI COPRIECC. D.17 x EC16 ROVERE COL.25	8	 (K) KIT DA 2 PEZZI DI PARACOLPI ADESIVI 10x1.5 NEUTRI	5
 (I) VITI MONTAGGIO ART. 553 C2 5x50 PZD ZINCATE	8	 (G) CRICCHETTO ART. 1263221 C/BASE SENZA BORDO GRIGIO	2
 (A) CIONDOLI DA 6x30 IN LEGNO FSC 100% ICILA-COC-002546	24	 (G1) VITI AUTOF. TP 3.5x12 ZINCATE	8
 (D) REGGIPIANO NYLON ART. 64 D.5 NEUTRO	20	 (D) 4,00 SUPPORTO ART. SO010 DA 18x13 INT. 8 NYLON BIANCO	12
 (F) FERMASCHIENALE ART. FM08 C/VITE 3.5X16 TRASPARENTE	54	 (J) 4,00 STAFFETTA ART. SO030 C/2 FORI INT. 8 NICHELATA	12
 (V) SQUADRETTA "L" FISSAGGIO MURO (FH0185) ZINCATA	2	 (Y) VITI EURO TP 6.3x9 T.R. (VE04) ZINCATE	24
 (V1) VITI AUTOF. TC 4x12 ZINCATE	2	 (Z) SET 2 GUIDE DA 300	3
 (P1) VITI AUTOF. TP 3.5X30 ZINCATE	6	 (Q) SET SISTEMA PUSH-PULL PER GUIDE	3
 (R2) CERNIERA D. 35 COLLO 0 SLA4800 AMMORTIZZATE SLIDE-ON	8		

# 01

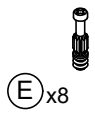

Ø4X12



Ø3,5X12

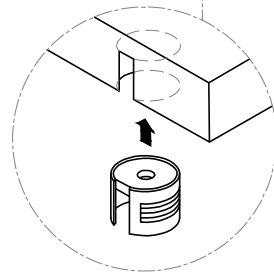
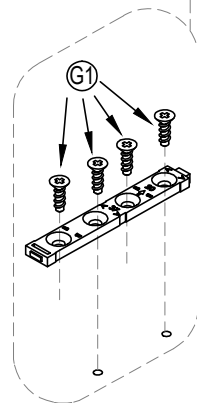
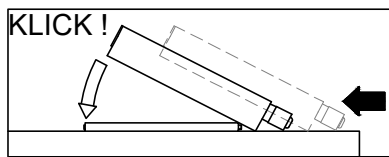
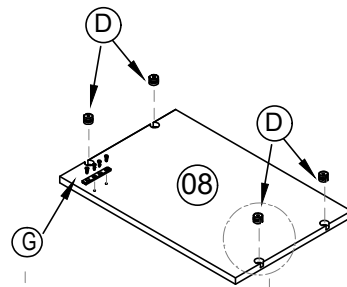
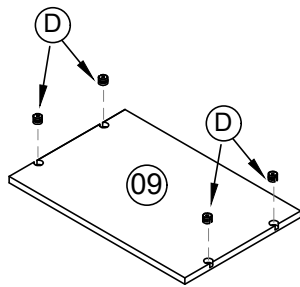
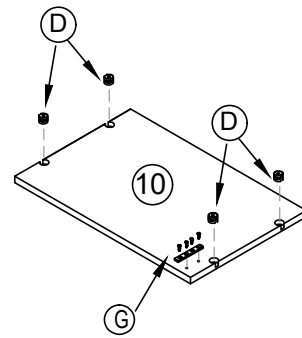
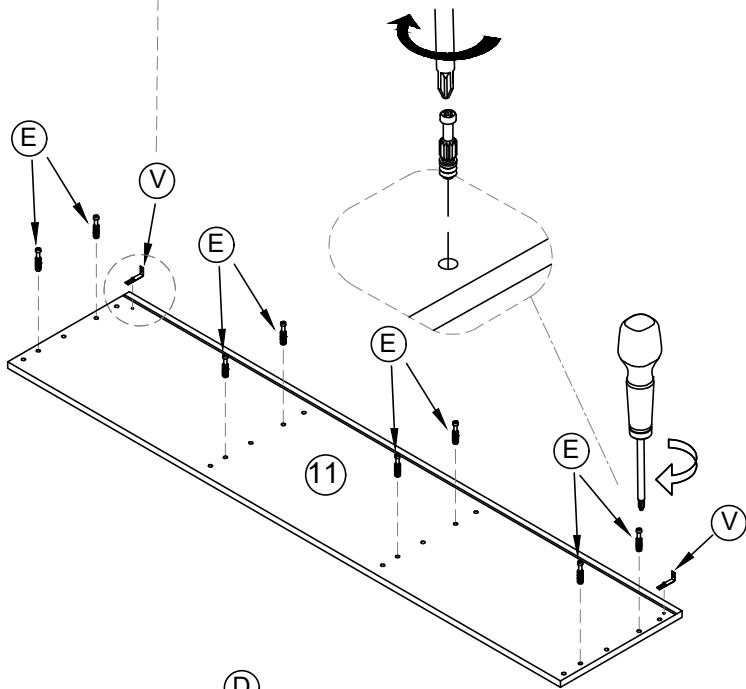
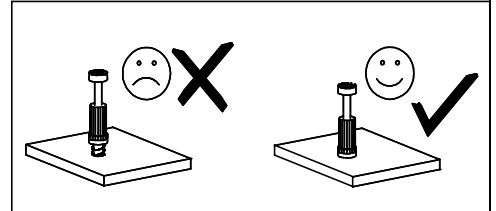
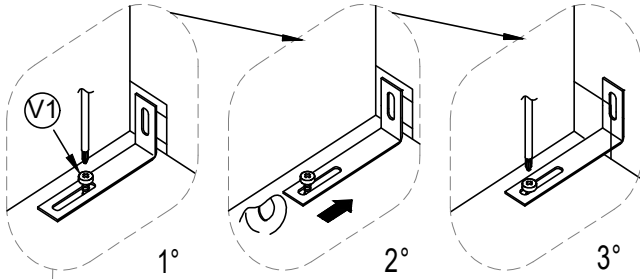
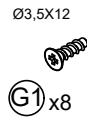



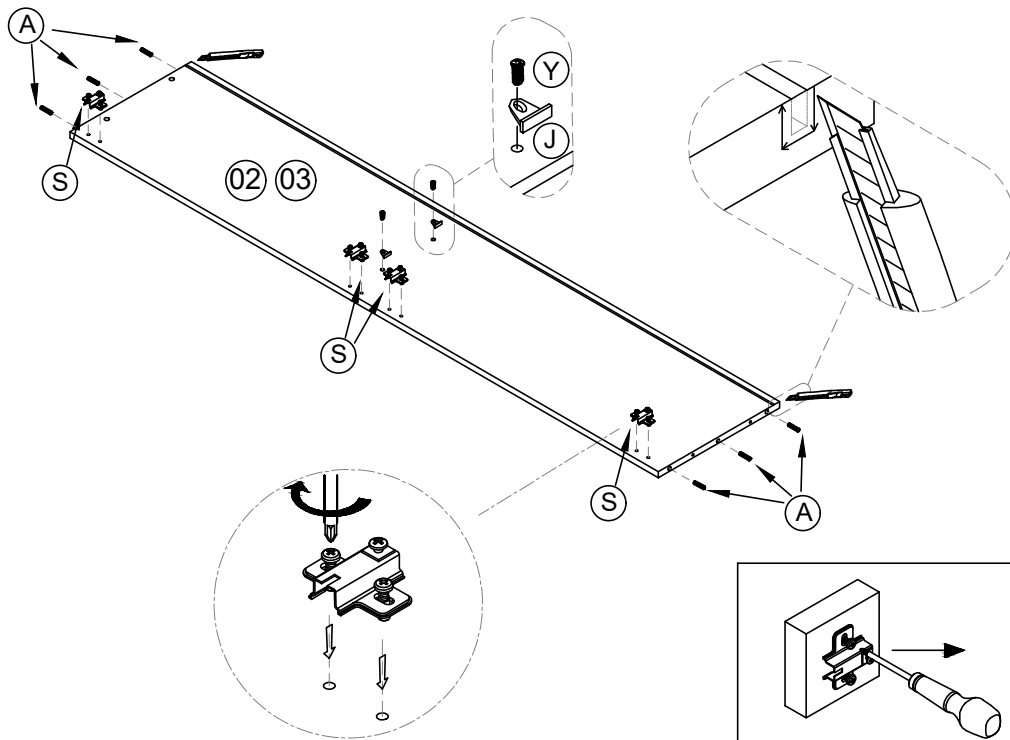
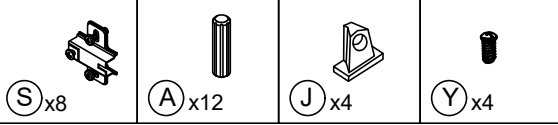

# 02

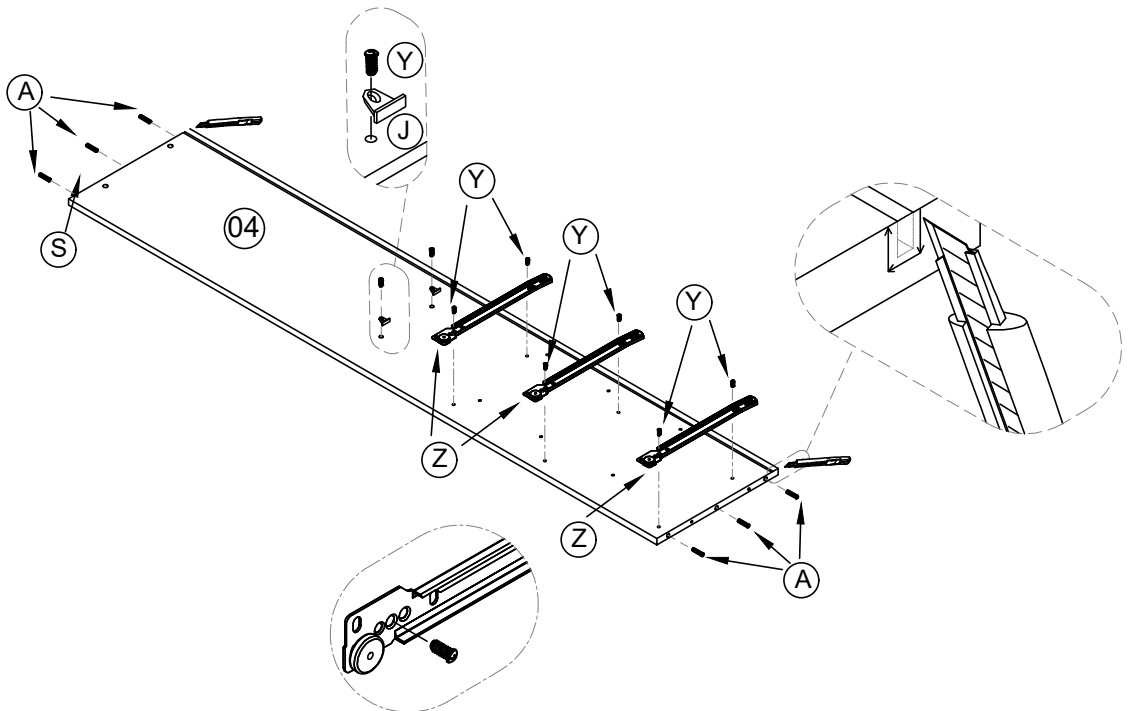
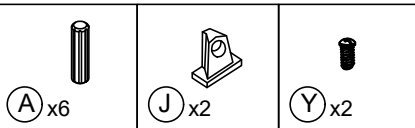

# 03





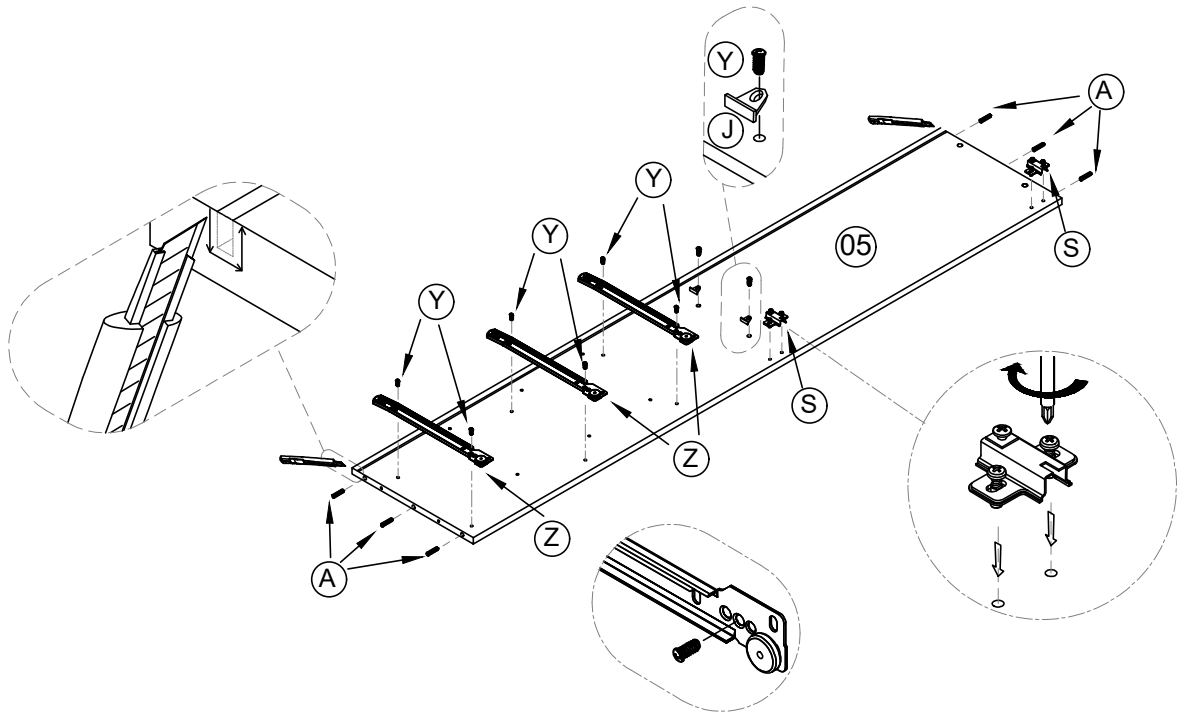

# 04

-  (A) x6
-  (J) x2
-  (Y) x2
-  (S) x2



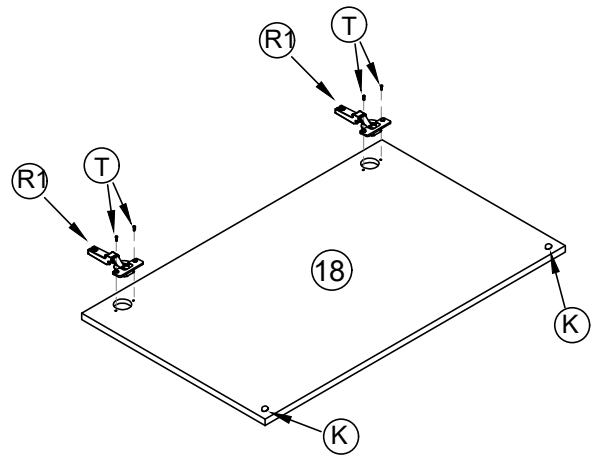
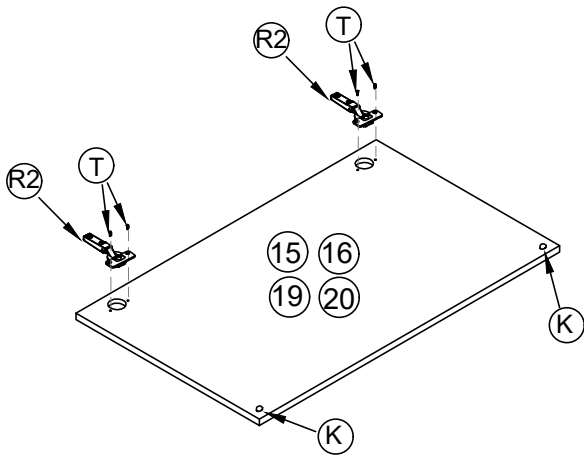
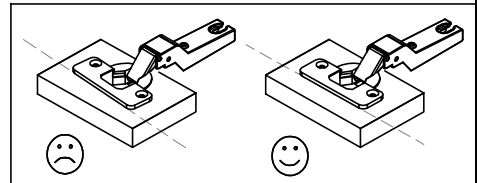

# 05

-  (R1) x2
  -  (R2) x8
  -  (T) x16
  -  (K) x8
- $\varnothing 3.5 \times 15$



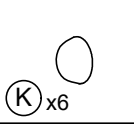
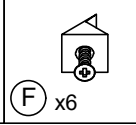
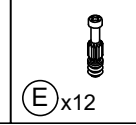

# 06

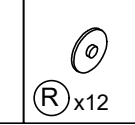
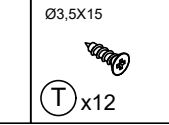
 K x6	 F x6	 E x12	 C x12	 R x12	 T x12
---	---	--	--	--	---

## 3x

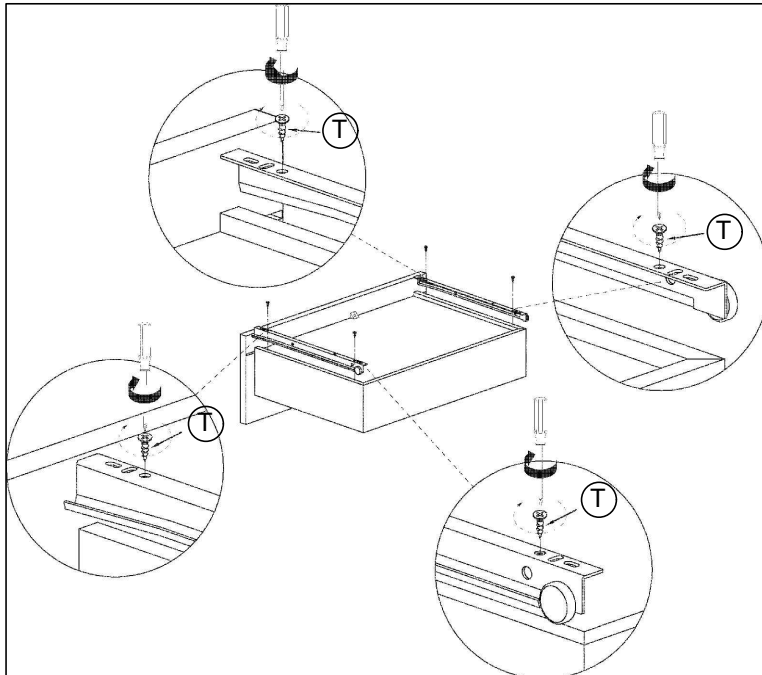
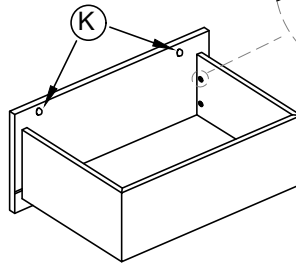
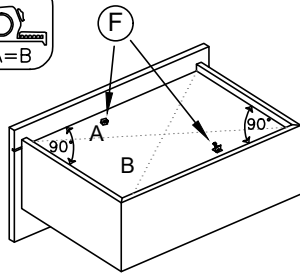
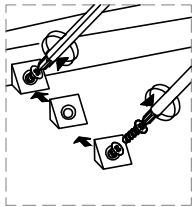
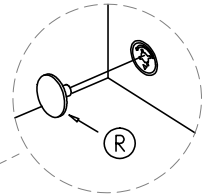
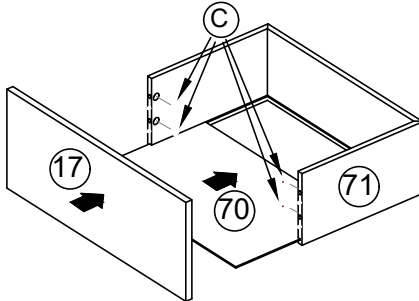
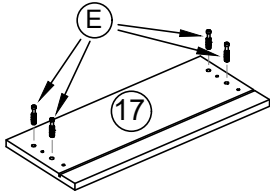
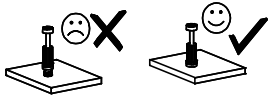

07

Q x3

3x

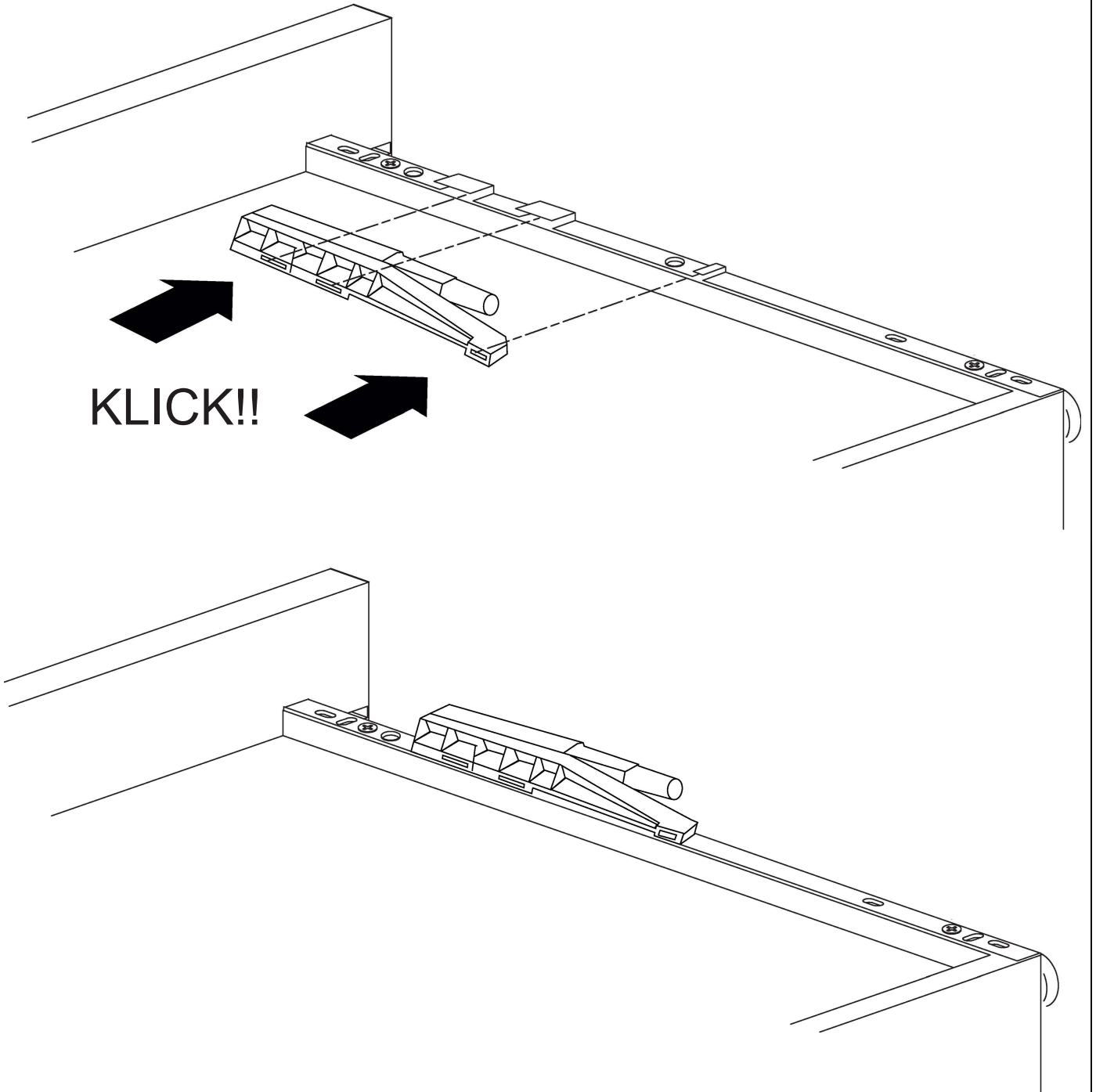

# 08

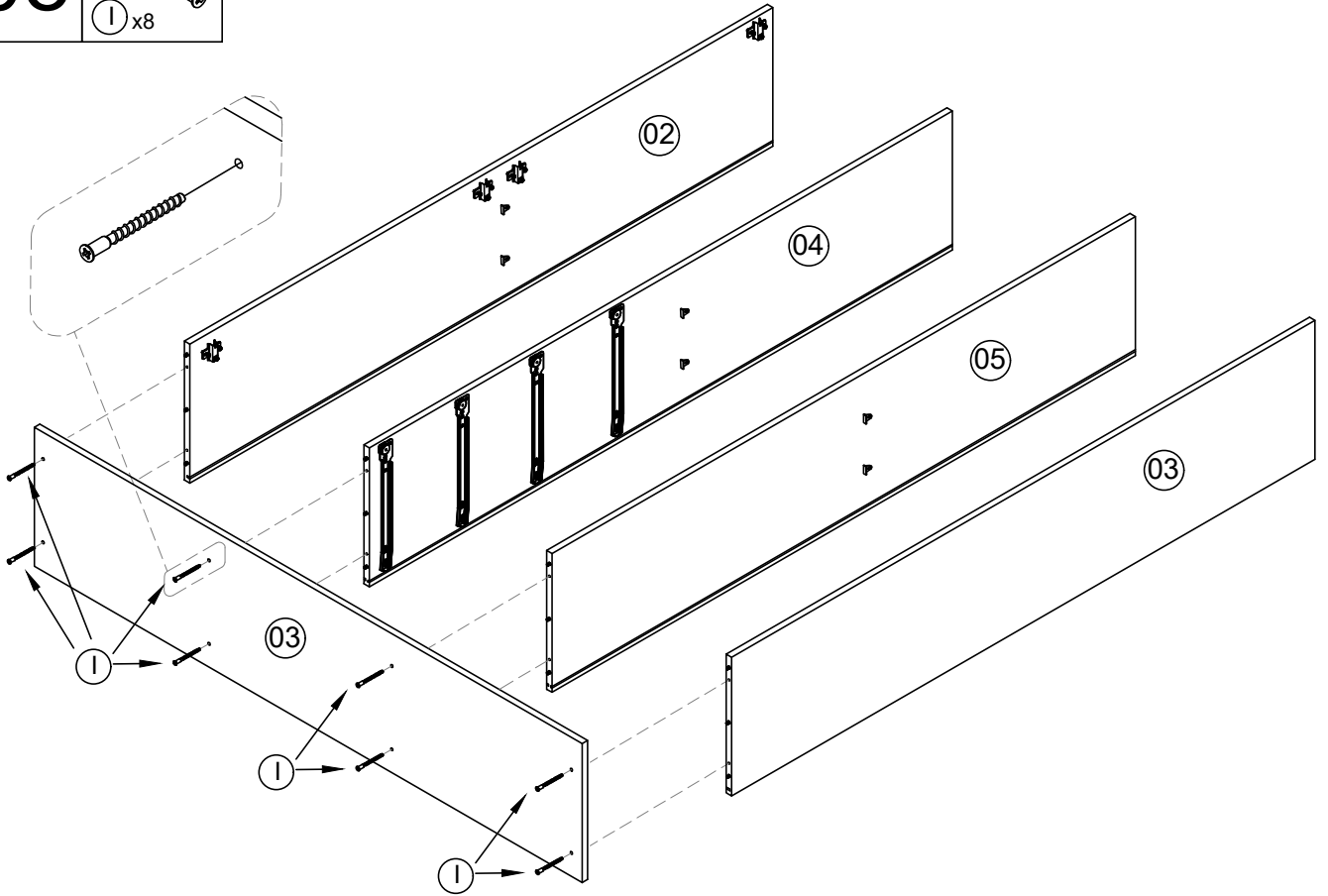
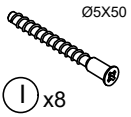

# 09

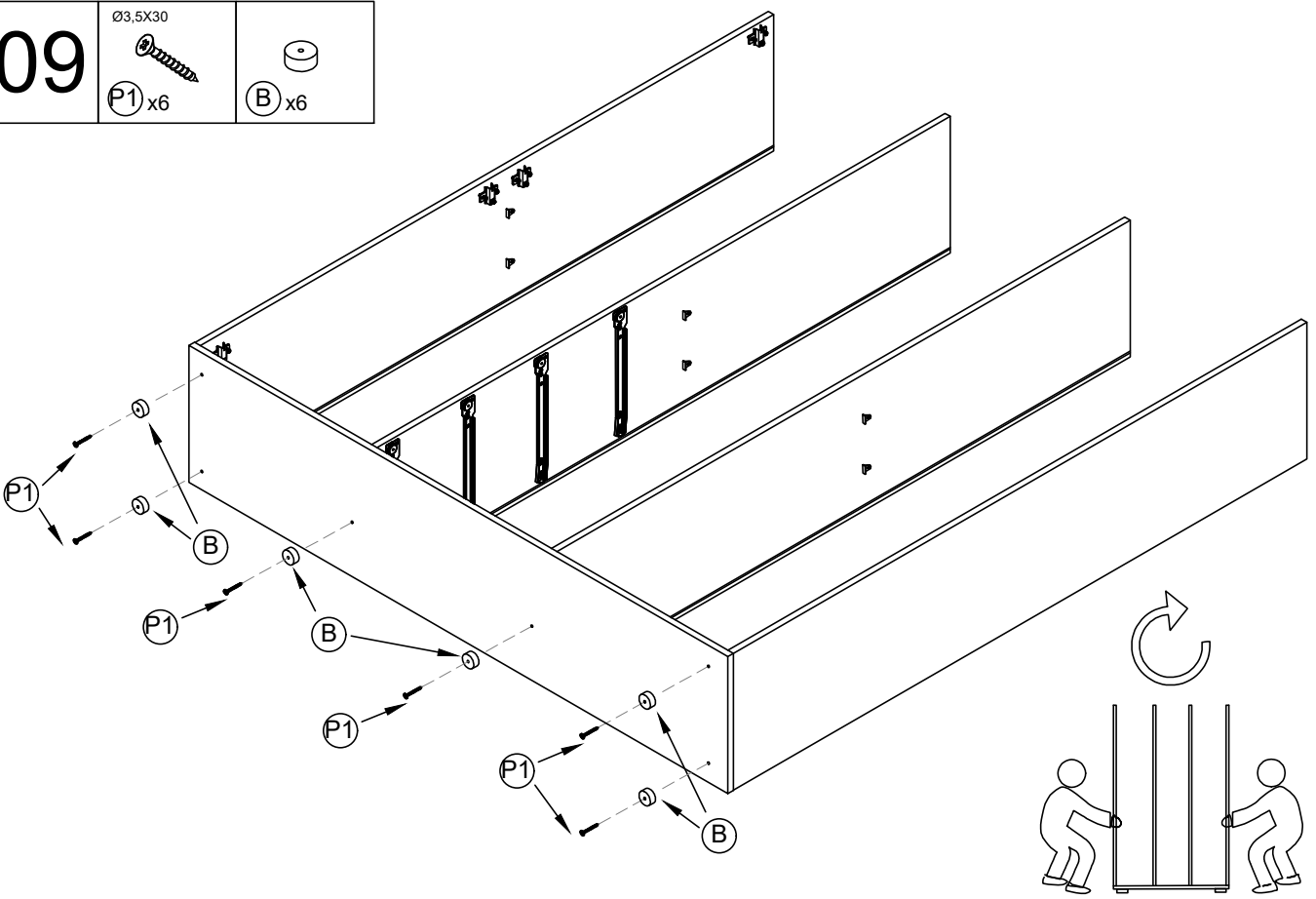
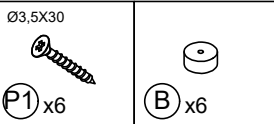

10

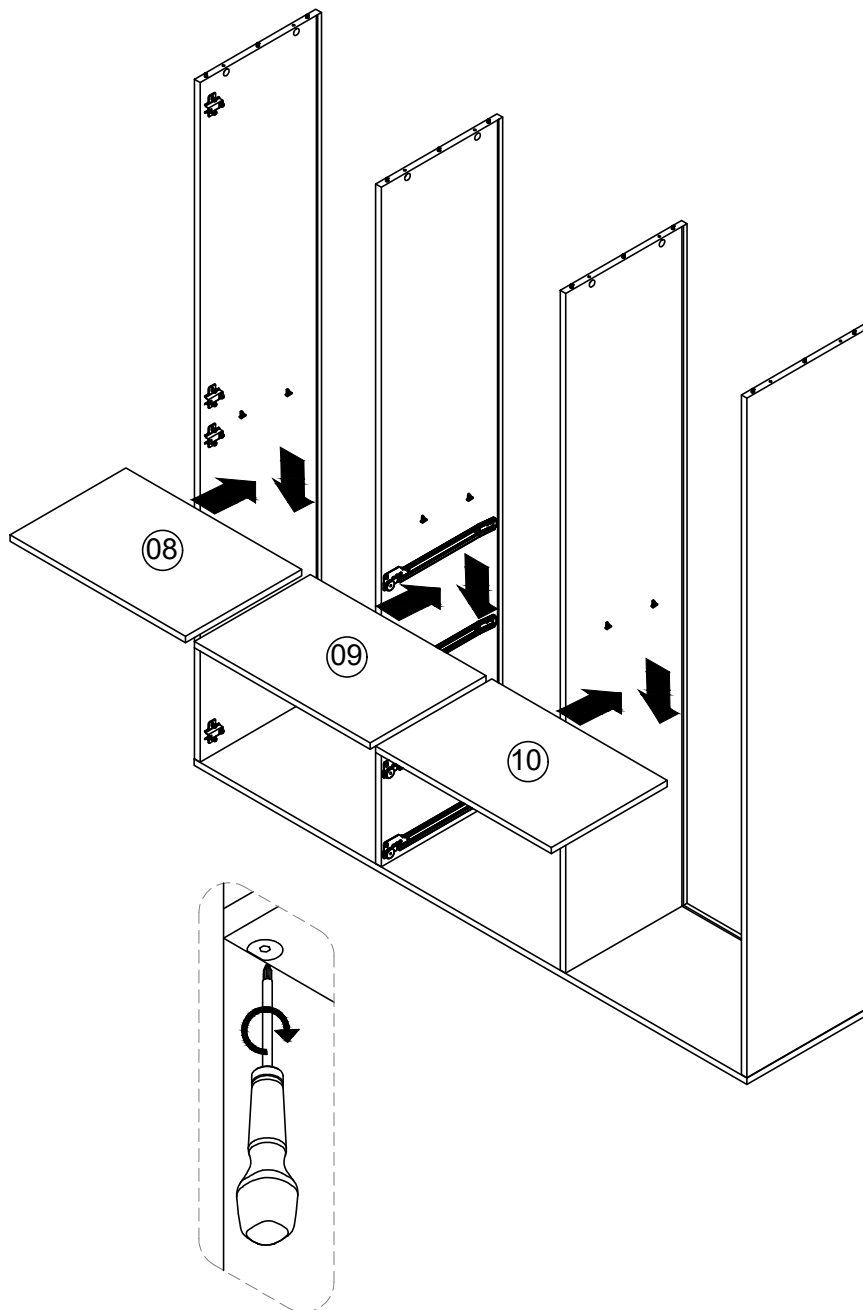

# 11

⊙  
Ⓜ x4

Ⓢ x4

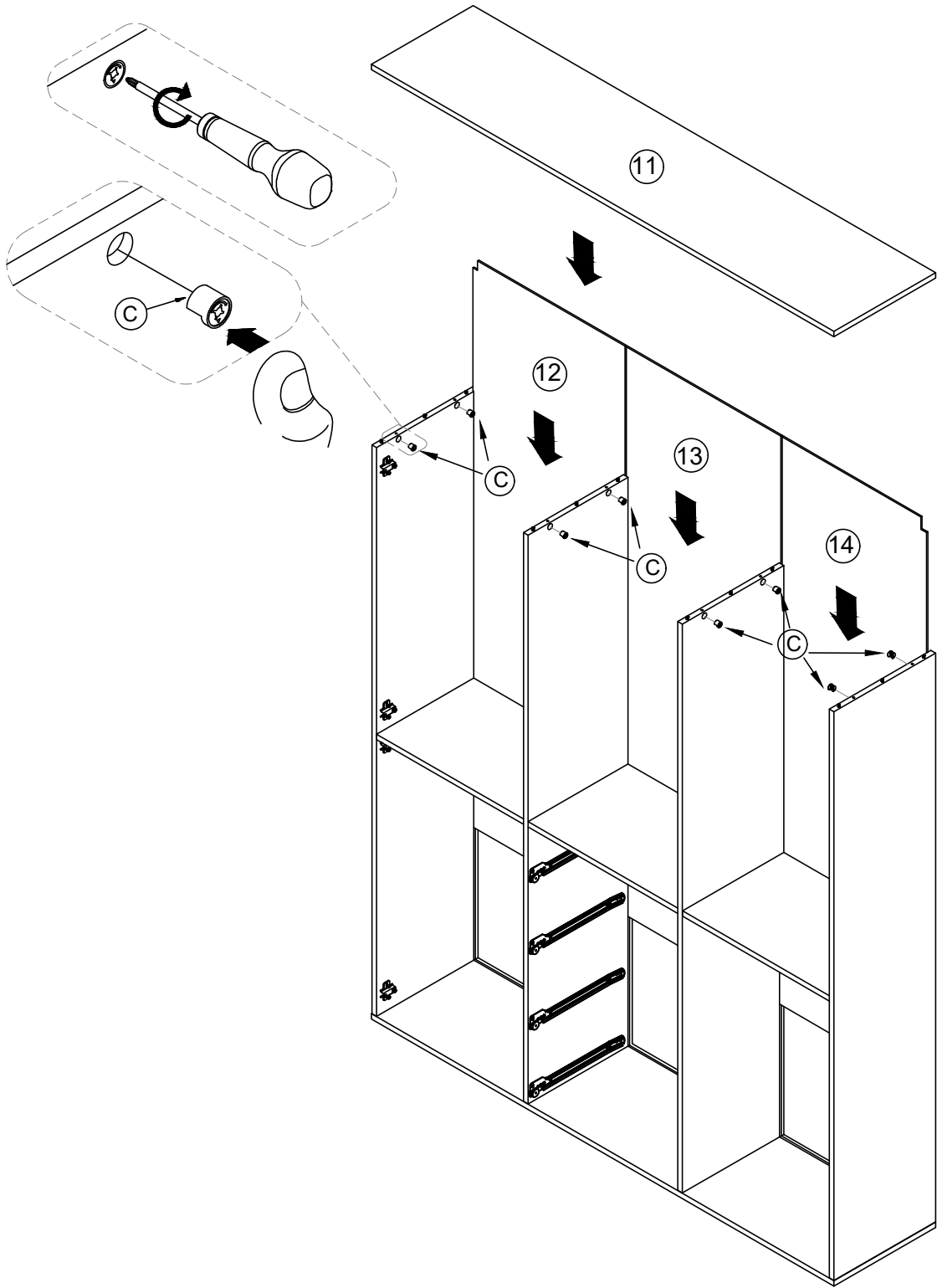

# 12

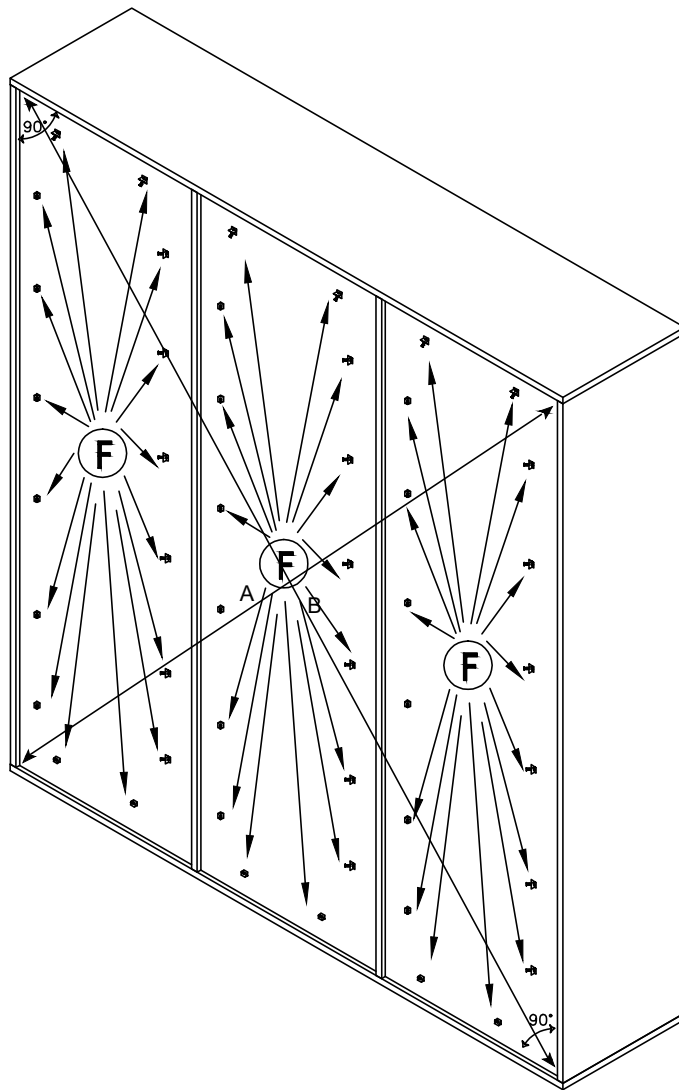
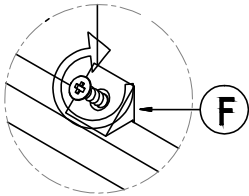
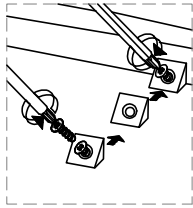
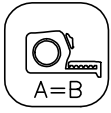
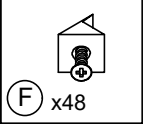

# 13

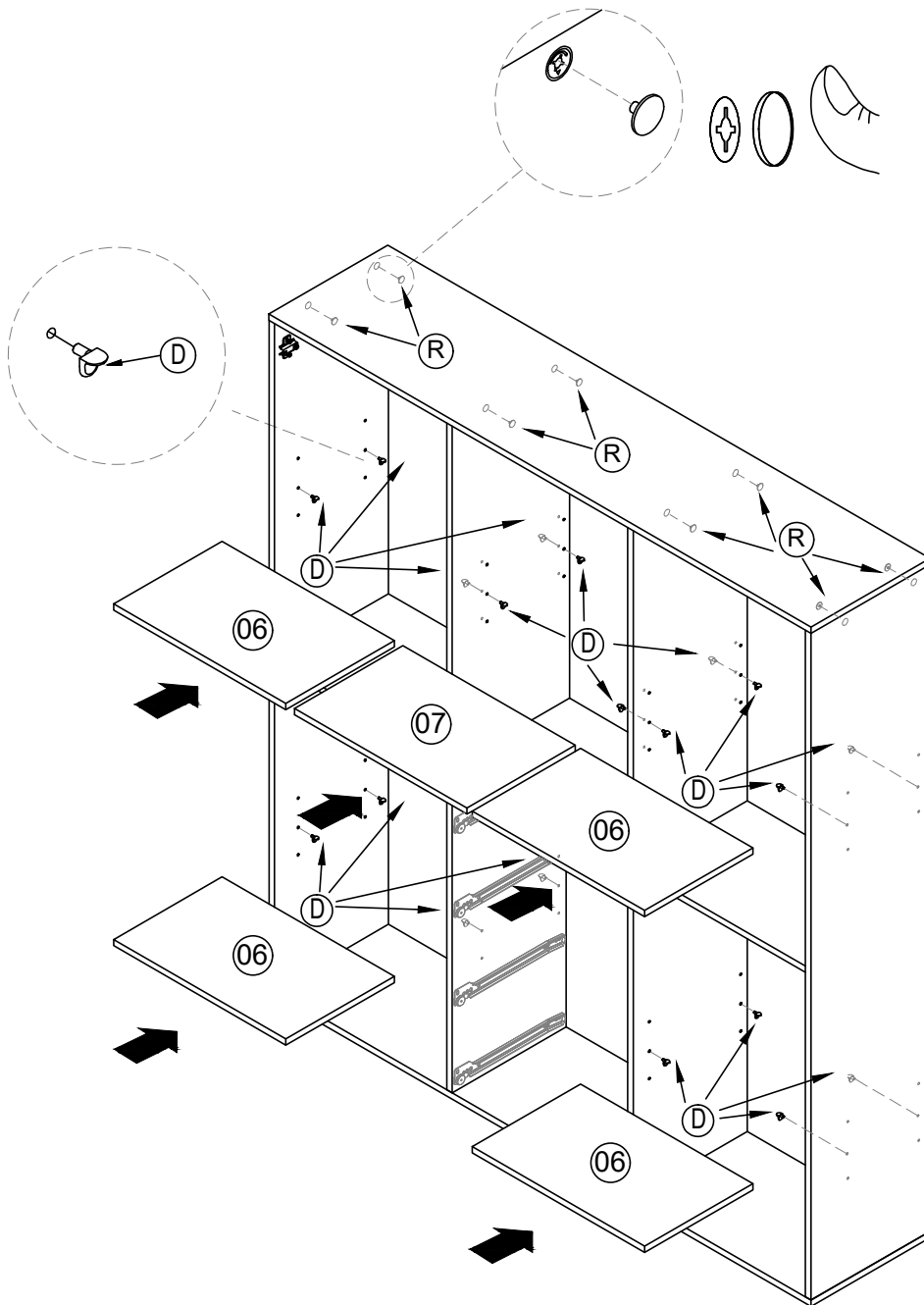

14

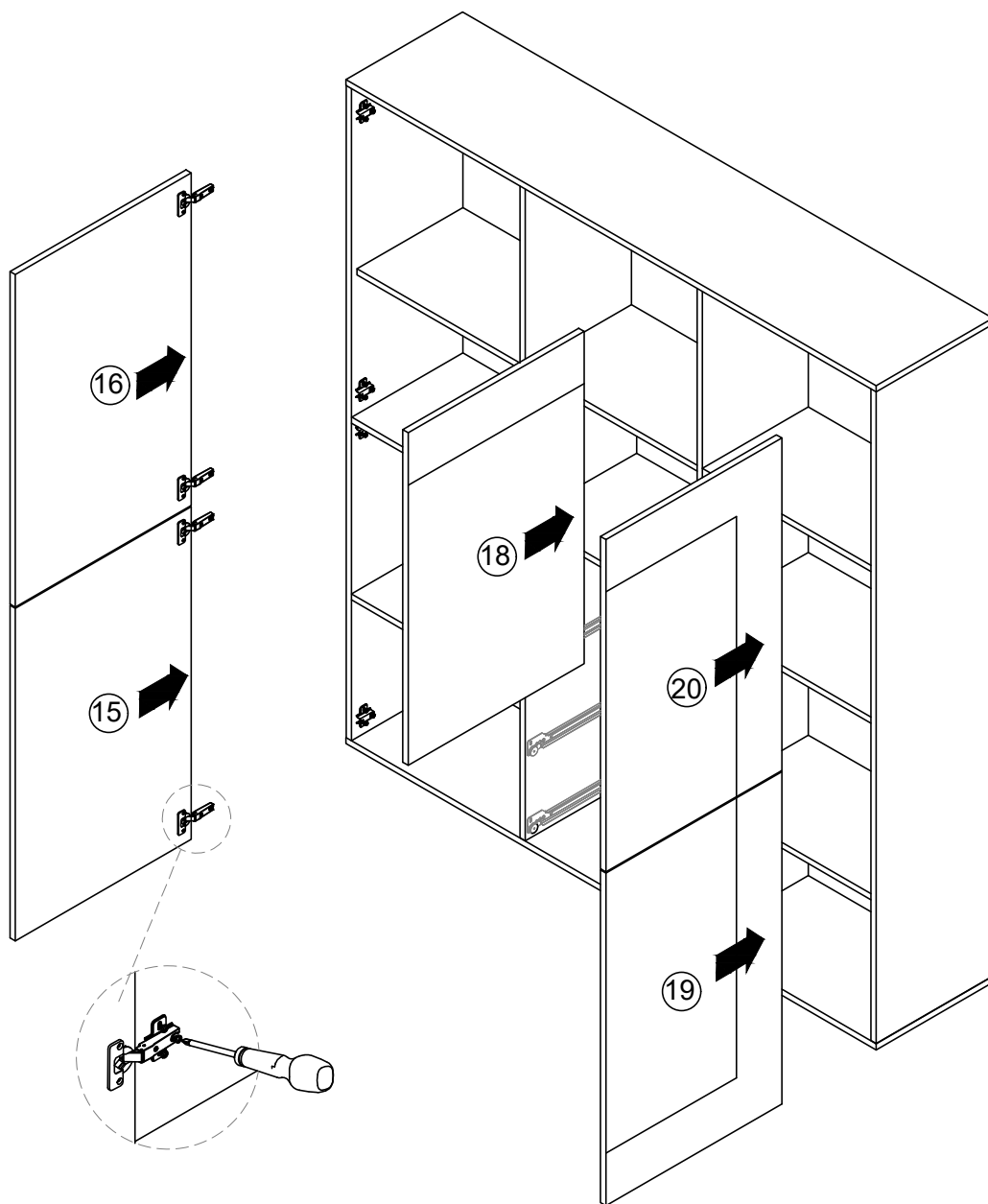

1°



2°



3°

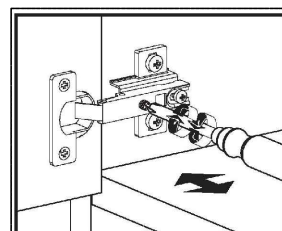
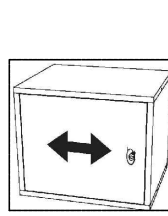
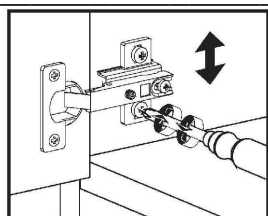
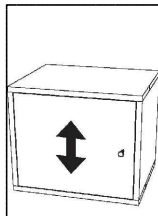
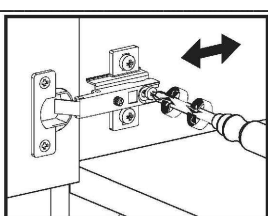
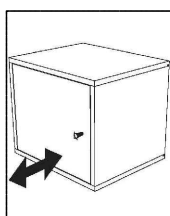
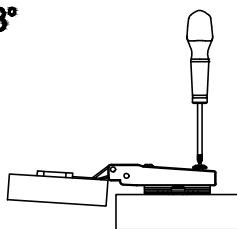



15

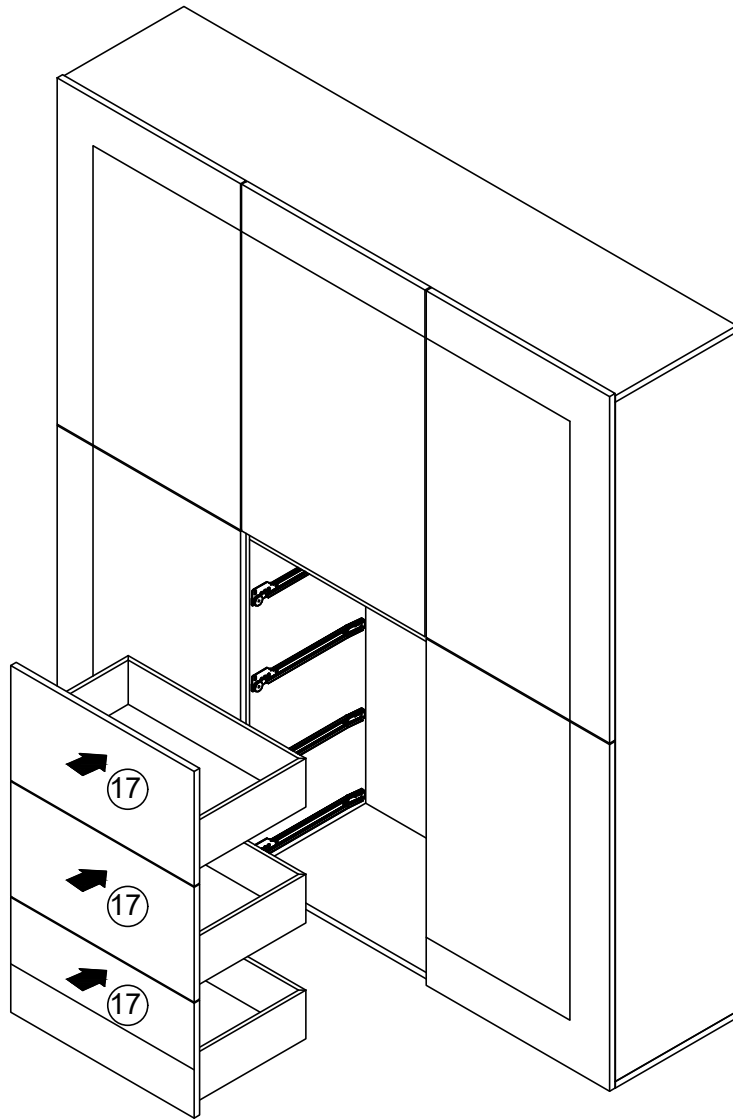

16

